



VICTORIA SQUARE ROOM SET UP GUIDE



ROOM 1, LEVEL 1

ROOM SET UP

DEFAULT SETUP - THEATRE

Please ensure you return room to default set-up after use.

OTHER CONFIGURATIONS:

STANDING COCKTAIL

150 including breakout area

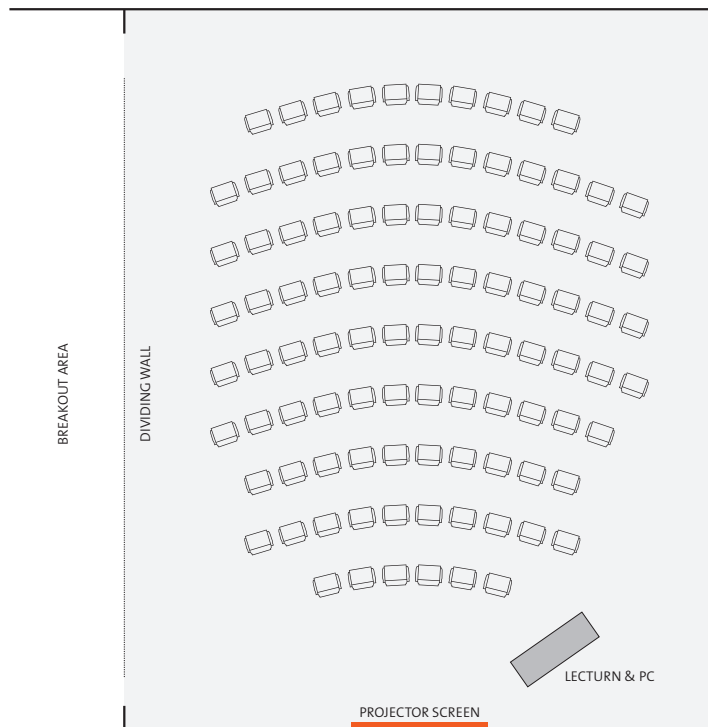

MODE AND CAPACITY

Theatre	U-Shape	Classroom (rows)	Workshop (groups)	Boardroom	Cocktail (standing)
100	NA	NA	NA	NA	150

ROOM 2, LEVEL 1

ROOM SET UP

DEFAULT SETUP - WORKSHOP

Please ensure you return room to default set-up after use.

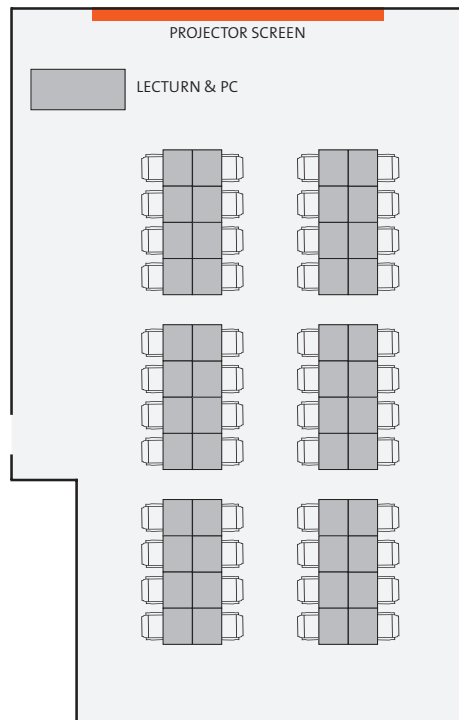

OTHER CONFIGURATIONS: STANDING COCKTAIL

50

U-SHAPE

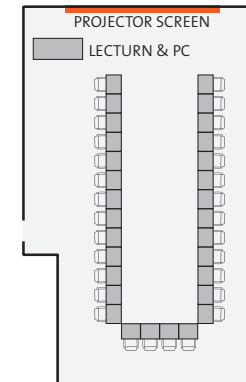

BOARDROOM

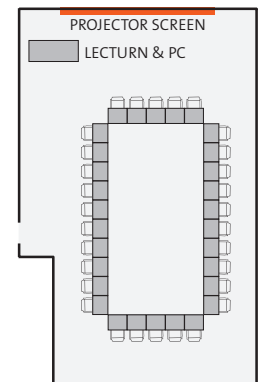

CLASSROOM

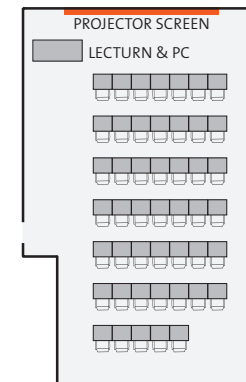

LECTURE

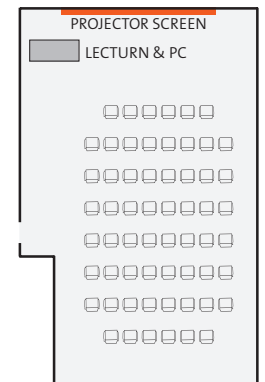

MODE AND CAPACITY					
Theatre	U-Shape	Classroom (rows)	Workshop (groups)	Boardroom	Cocktail (standing)
60	30	50	48	30	50

ROOM 3, LEVEL 1

ROOM SET UP

DEFAULT SETUP - BOARDROOM

Please ensure you return room to default set-up after use.

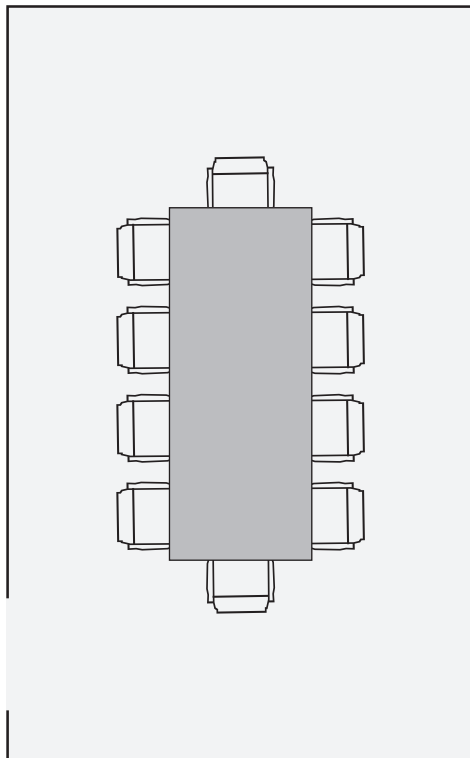

MODE AND CAPACITY

Theatre	U-Shape	Classroom (rows)	Workshop (groups)	Boardroom	Cocktail (standing)
NA	NA	NA	NA	10	NA

ROOM 4, LEVEL 1 ROOM SET UP

DEFAULT SETUP - CLASSROOM

Please ensure you return room to default set-up after use.

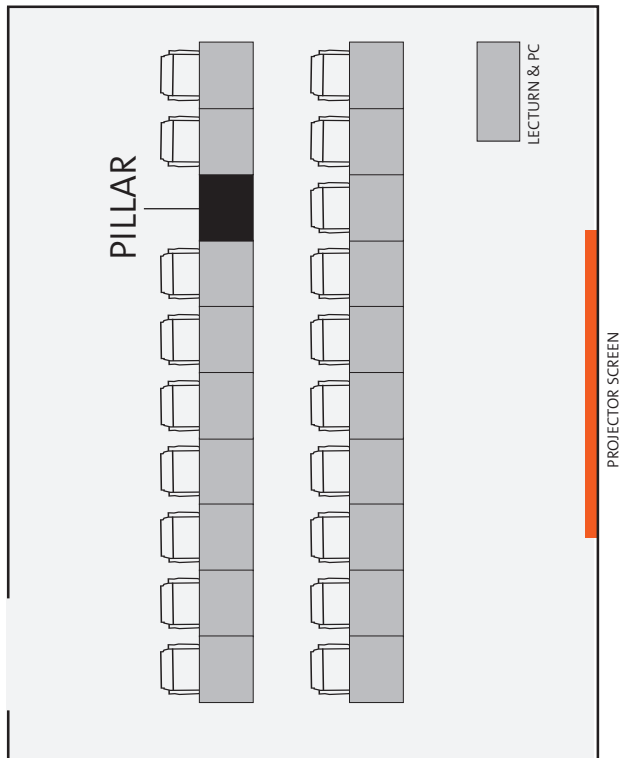

OTHER CONFIGURATIONS:

U-SHAPE

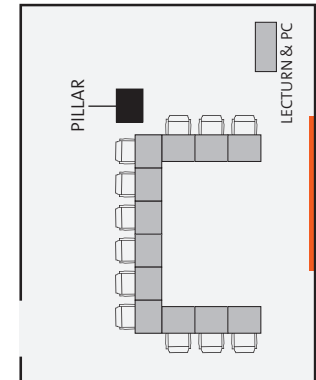

BOARDROOM

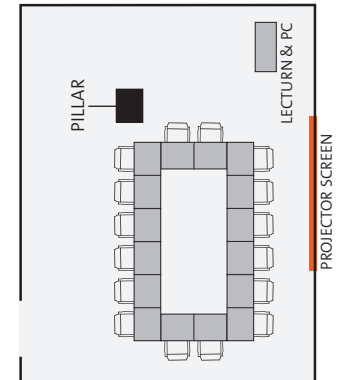

WORKSHOP

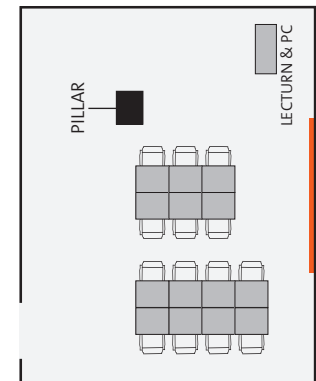

LECTURE

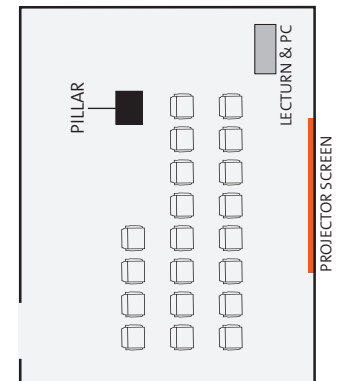

MODE AND CAPACITY

Theatre	U-Shape	Classroom (rows)	Workshop (groups)	Boardroom	Cocktail (standing)
20	12	19	14	16	NA

ROOM 5, LEVEL 1

ROOM SET UP

DEFAULT SETUP - BOARDROOM

Please ensure you return room to default set-up after use.

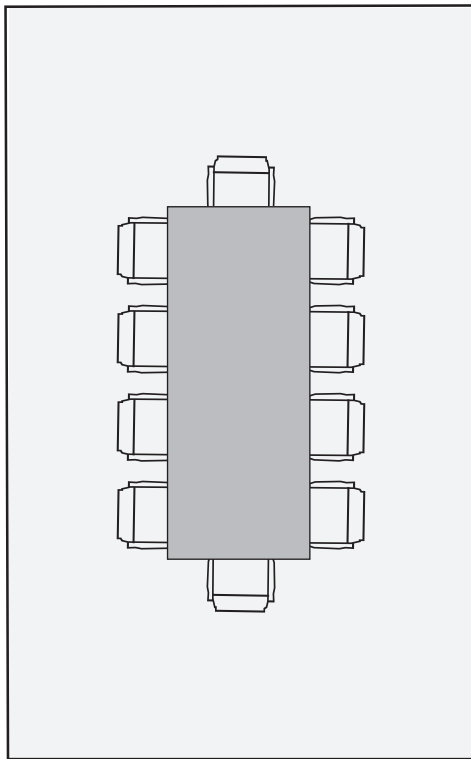

MODE AND CAPACITY

Theatre	U-Shape	Classroom (rows)	Workshop (groups)	Boardroom	Cocktail (standing)
NA	NA	NA	NA	10	NA

LEVEL 2 ROOMS (2.1-2.2-2.3)

ROOM SET UP

DEFAULT SETUP - WORKSHOP

Please ensure you return room to default set-up after use.

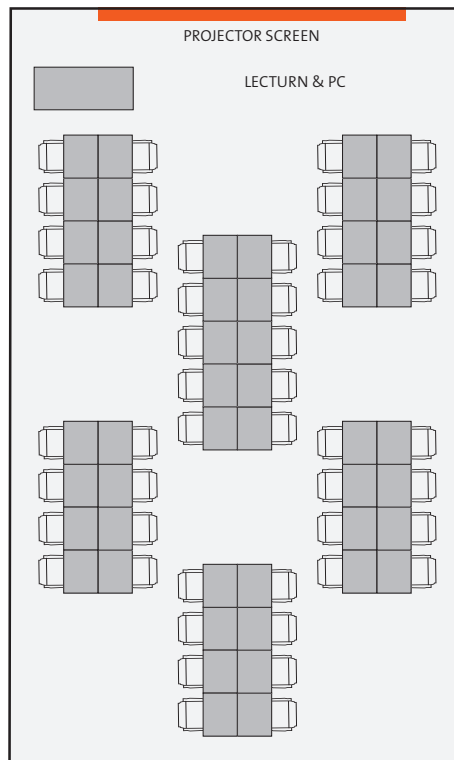

OTHER CONFIGURATIONS: STANDING COCKTAIL

60

U-SHAPE

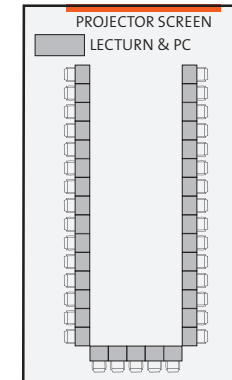

BOARDROOM

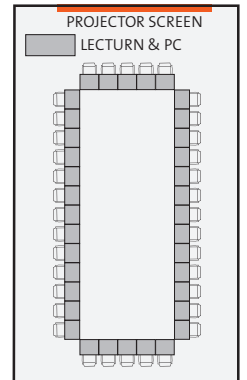

CLASSROOM

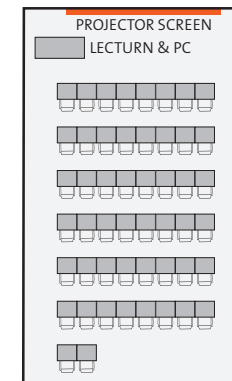

LECTURE

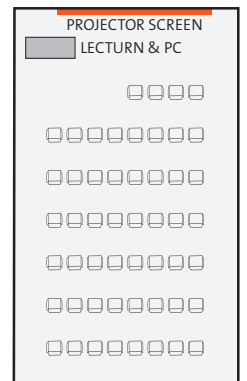

MODE AND CAPACITY

Theatre	U-Shape	Classroom (rows)	Workshop (groups)	Boardroom	Cocktail (standing)
50	35	50	50	36	60

LEVEL 10 ROOMS (10.1-10.2-10.3)

ROOM SET UP

DEFAULT SETUP - WORKSHOP

Please ensure you return room to default set-up after use.

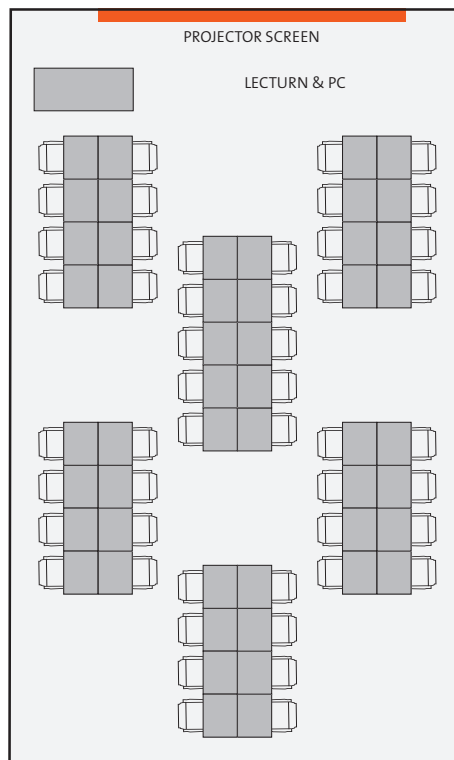

OTHER CONFIGURATIONS:

STANDING COCKTAIL

60

U-SHAPE

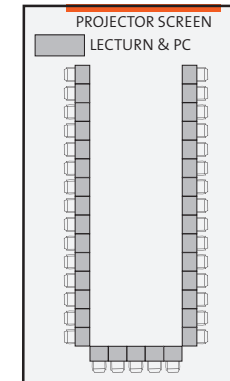

BOARDROOM

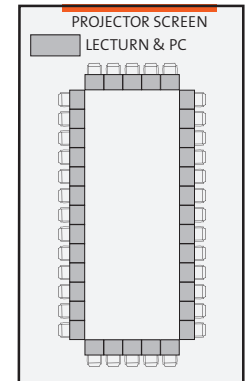

CLASSROOM

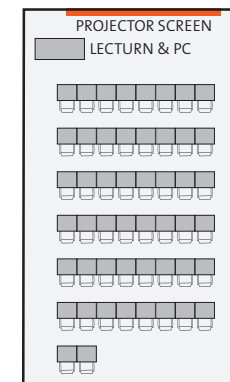

LECTURE

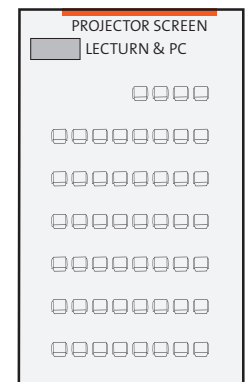

MODE AND CAPACITY

Theatre	U-Shape	Classroom (rows)	Workshop (groups)	Boardroom	Cocktail (standing)
50	35	50	50	36	60

LEVEL 11 ROOMS - BOARDROOMS NORTH & SOUTH

ROOM SET UP

DEFAULT SETUP - SEPERATE BOARDROOMS

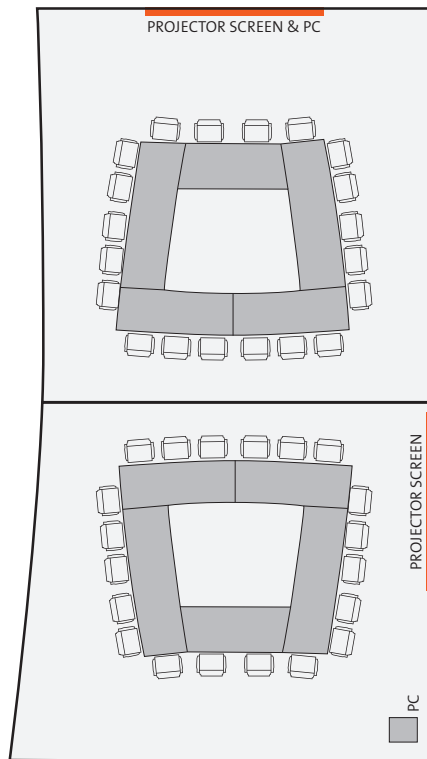

OTHER CONFIGURATIONS: STANDING COCKTAIL

Seperate boardrooms - 30 per room
 Combined boardroom - 60

COMBINED BOARDROOM

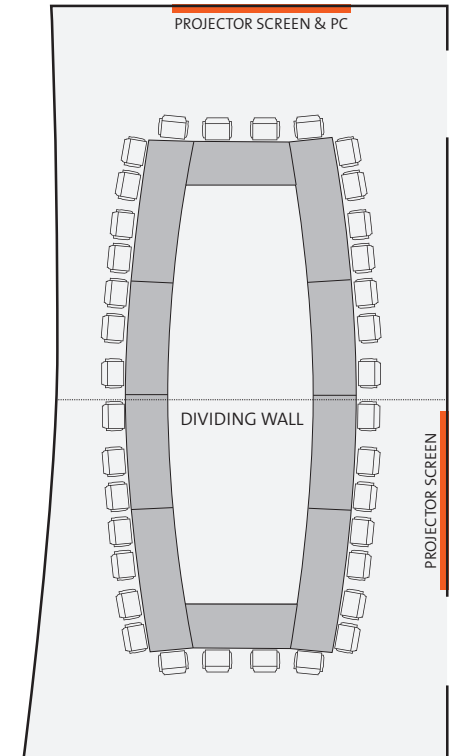

MODE AND CAPACITY

Theatre	U-Shape	Classroom (rows)	Workshop (groups)	Boardroom	Cocktail (standing)
NA	NA	NA	NA	18 per room	30 per room

